

# AKZ4301/..KD-5.08-BASALTGREY

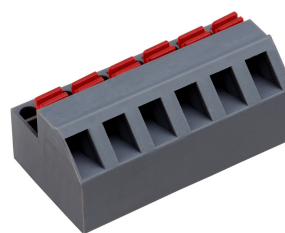



**PTR**

A Phoenix Mecano Brand

## Technical Data

Wire sizes		Insulating Material	
Solid min	0.08 mm <sup>2</sup>	Material	PA 6.6
Solid max	1.5 mm <sup>2</sup>	Flammability Class	UL 94 V-0
Stranded (flexible) min	0.20mm <sup>2</sup>	<b>Temperatures</b>	
Stranded (flexible) max	1.5 mm <sup>2</sup>	Operating Temperature (without mech. load)	-40 °C - 105 °C
Stranded with Ferrule min	0.14 mm <sup>2</sup>	Store Temperature	-40 °C - 105 °C
Stranded with Ferrule max	1.0 mm <sup>2</sup>	<b>Wave Soldering Process</b>	
<b>Dimensions</b>		Soldering Temperature, recommended	260 °C
Stripped Length	11.0 mm	Peak Soldering Time, recommended	3-4 s
PCB Hole Diameter	1.4 mm	<b>Reflow Process</b>	
<b>Materials</b>		Soldering Temperature, recommended	-
Solder Tab	Brass	Peak Soldering Time, recommended	-
Clamp Spring	Stainless Steel		

## Colours

	BASALT GREY, RAL 7012
	GREEN, RAL 6018
	LIGHT GREEN, similar RAL 6018

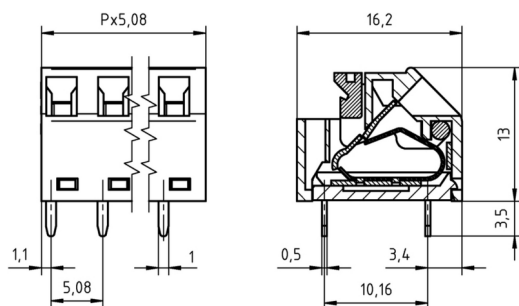

Colours according to RAL, there may be variations on colour due to production conditions. Special colours on request.



## Order Data (Spacing 5.08 mm)

Poles	Width (mm)	Article Designation	Article Number	PU
2	10.16	AKZ4301/2KD-5.08-BASALTGREY	54301020421 D	50
3	15.24	AKZ4301/3KD-5.08-BASALTGREY	54301030421 D	50
4	20.32	AKZ4301/4KD-5.08-BASALTGREY	54301040421 D	50
5	25.40	AKZ4301/5KD-5.08-BASALTGREY	54301050421 D	50
6	30.48	AKZ4301/6KD-5.08-BASALTGREY	54301060421 D	50
7	35.56	AKZ4301/7KD-5.08-BASALTGREY	54301070421 D	50
8	40.64	AKZ4301/8KD-5.08-BASALTGREY	54301080421 D	50

## Ratings

UseGroup						
	B	C	D			
Rated Voltage	300 V	-	300 V	250 V		
Rated Current	10 A	-	10 A	16 A		
Rated Wire Size	min					max
- solid	AWG 22-16	-	AWG 22-16	0.2 mm <sup>2</sup>	1.5 mm <sup>2</sup>	
- stranded	AWG 22-16	-	AWG 22-16	0.2 mm <sup>2</sup>	1.5 mm <sup>2</sup>	
Test Voltage	1.60 kV	-	1.60 kV	2.0 kV		