

STLZ990/..-10.16-GREEN





A Phoenix Mecano Brand

Technical Data

Wire sizes		Insulating Material	
Solid min	-	Material	PA 6.6
Solid max	-	Flammability Class	UL 94 V-0
Stranded (flexible) min	-	Temperatures	
Stranded (flexible) max	-	Operating Temperature (without mech. load)	-40 °C - 105 °C
Stranded with Ferrule min	-	Store Temperature	-40 °C - 105 °C
Stranded with Ferrule max	-	Wave Soldering Process	
Dimensions		Soldering Temperature, recommended	260 °C
PCB Hole Diameter	1.4 mm	Peak Soldering Time, recommended	3-4 s
Materials		Reflow Process	
Contact Pin	Copper Alloy	Soldering Temperature, recommended	-
		Peak Soldering Time, recommended	-

Colours

-  GREEN, RAL 6018
-  LIGHT GREEN, similar RAL 6018

Colours according to RAL, there may be variations on colour due to production conditions. Special colours on request.

Counterparts (Spacing 10.16 mm)

Terminal Block			
AKZ950	AKZ1100	AKZ1110	AKZ1200

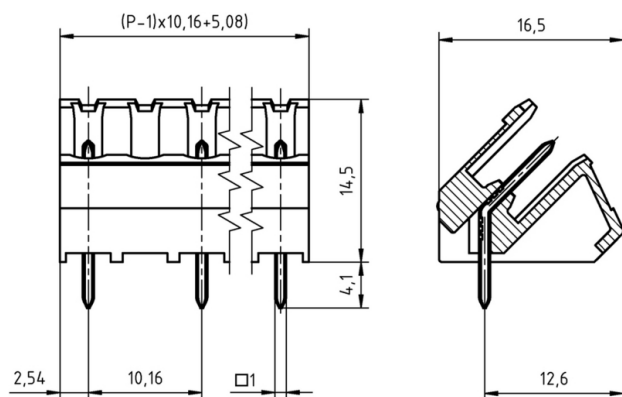

In combination of connectors with different admission data, the lower value is valid.





Order Data (Spacing 10.16 mm)

Poles	Width (mm)	Article Designation	Article Number	PU
2	15.24	STLZ990/2-10.16-GREEN	50990025171 F	200
3	25.40	STLZ990/3-10.16-GREEN	50990035171 E	100
4	35.56	STLZ990/4-10.16-GREEN	50990045171 E	100
5	45.72	STLZ990/5-10.16-GREEN	50990055171 D	50
6	55.88	STLZ990/6-10.16-GREEN	50990065171 D	50
7	66.04	STLZ990/7-10.16-GREEN	50990075171 D	50
8	76.20	STLZ990/8-10.16-GREEN	50990085171 D	50
9	86.36	STLZ990/9-10.16-GREEN	50990095171 D	50
10	96.52	STLZ990/10-10.16-GREEN	50990105171 D	50
11	106.68	STLZ990/11-10.16-GREEN	50990115171 D	50
12	116.84	STLZ990/12-10.16-GREEN	50990125171 D	50

Accessoires

Figure	Designation	Article Number
	Coding Star CS2-5.0/5.08-RED	Order Data: 50000000024
	Separating Element SE-STL950-GREEN	Order Data: 50950000002

Ratings

UseGroup	C  US			
	B	C	D	
Rated Voltage	300 V	150 V	300 V	630 V
Rated Current	15 A	15 A	-	12 A
Overvoltage Category				III
Test Voltage	1.60 kV	1.30 kV	1.60 kV	6.0 kV
Pollution Degree				3